

High performance luminaires designed to minimise light pollution and energy consumption

Stylish IP66 wall mounted luminaires. High-pressure die-cast aluminium body with a high efficiency polycarbonate refractor. Less than 2% upward light.

Applications: Wide versions ideal for uniform pathway lighting for schools, hospitals, retail and other commercial environments. Area version ideal for general area lighting requiring a forward throw light distribution.

Realta Micro also available for low light level applications or emergency exit lighting. Ligature-resistant versions available.

- Strong high-pressure die-cast LM2 aluminium body with high efficiency prismatic polycarbonate front cover
- Wide distribution or area distribution options
- Highly specular, multi-faceted injection moulded vacuum metallised reflector on wide distribution versions
- Excellent distribution with less than 2% upward light component
- Optional photocell control
- SmartScan wireless technology removes the need for control cabling. Ideal for retro-fit



IP66

Up to IK11

Up to 127.6 LL/CW

SMARTSCAN

Specification

Mounting	Surface	IP rating	IP66
Impact rating	Up to IK11	Max presence detection height	8 m

Lighting

Optic	Clear cover Prismatic cover	Lumen output	1,320 lm - 5,635 lm
Efficacy	Up to 127.6 LL/CW		

Emergency data

Emergency lumen output	365 lm - 385 lm	Emergency type	Maintained
Emergency duration	3 hours	Battery specification	Nickel Metal Hydride (NiMH)

Power

LED power	8 W - 42 W	Circuit power	11 W - 47 W
-----------	------------	---------------	-------------

LED characteristics

CRI	70+ 80+	Colour temperature	4000 K
Rated life (hours)	Up to 100 K - L90/B10		

Compliance

UKCA	Yes	CE	Yes
Energy efficiency class	This product contains a light source of energy efficiency class A This product contains a light source of energy efficiency class C		

Dimensions

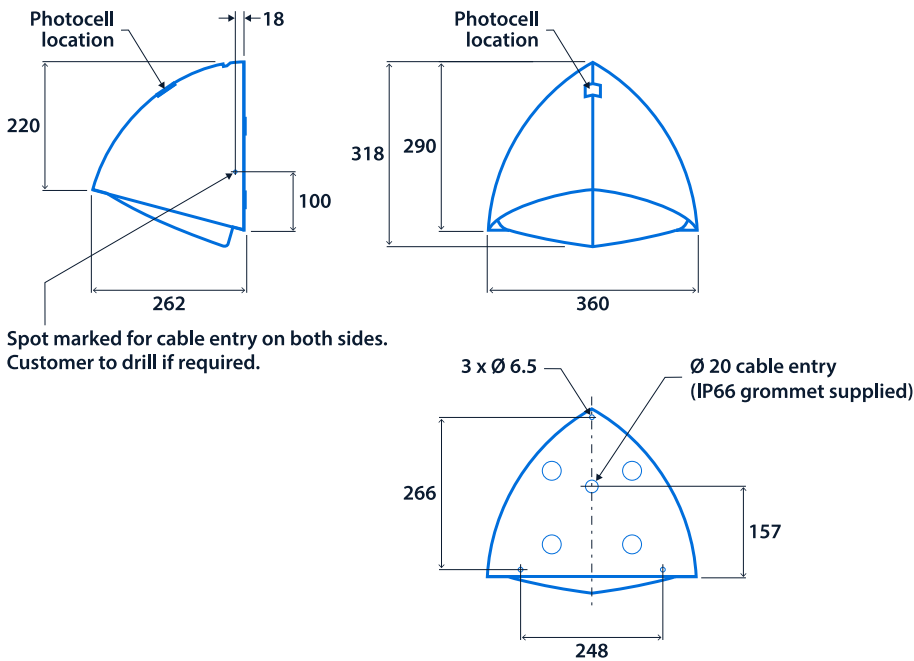

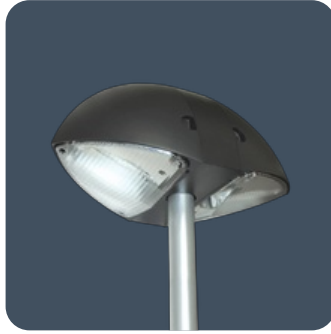
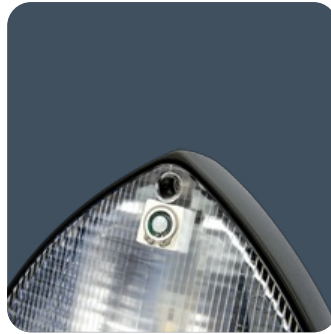

Click or scan here
View Realta variants using our
online filtering tool



Information is correct as of 30 Jan 2025, however must not be interpreted as a guarantee of individual product performance and/or characteristics. We reserve the right to alter specifications and designs without prior notice.