

Low glare recessed linear downlight luminaires

Flexblox is a slimline, linear downlight with low glare optics that can enliven simple grid layouts. By orientating Flexblox luminaires, creative and innovative lighting designs can be created. Flexblox can be recessed into different ceiling types to produce a minimal aesthetic for a variety of applications. With a choice of three optical reflectors, the luminaire brightness can suit the requirements of the space.

Flexblox MultiDrive can save on installation costs whilst increasing flexibility by powering multiple luminaires from one gear box and allowing the wattage to be set on site via the integrated wattage selector.

Applications: reception areas, corridors, meeting rooms, offices, teaching spaces, libraries, retail and circulation/breakout spaces.

- Black 'invisible' light source, metallised low glare and white reflector options
- MultiDrive technology versions with remote gear box powering up to 4 luminaires
- Rapid installation MultiDrive versions using 3 m lead and plugs (emergency versions use a 1 m lead)
- MultiDrive versions with wattage selectable during installation
- Supplied with reinforcing plate including cut aperture template
- SmartScan wireless technology removes the need for control cabling. Ideal for retro-fit

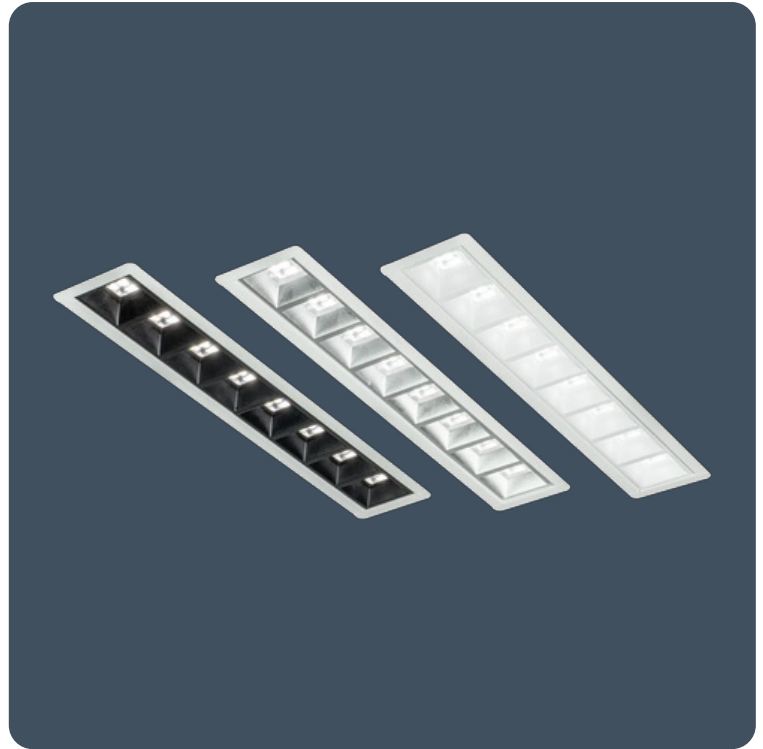

IP40

Up to 139.7 LL/CW

Lighting management

Lighting control system	Dimming (DALI) Non-dimming SmartScan Internal	Emergency system	DALI / Self-Test Emergency Non-emergency SmartScan Emergency Standard Emergency
-------------------------	---	------------------	--

Specification

Mounting	Recessed	IP rating	IP40
Max presence detection height	8 m		

Lighting

Lumen output	1,100 lm - 2,515 lm	Efficacy	Up to 139.7 LL/CW
--------------	---------------------	----------	-------------------

Emergency data

Emergency type	Maintained	Emergency duration	3 hours
Battery specification	Nickel Metal Hydride (NiMH)		

Power

LED power	8 W - 16 W	Circuit power	9 W - 20 W
-----------	------------	---------------	------------

LED characteristics

CRI	80+	Colour temperature	4000 K
Rated life (hours)	100 K - L80/B10		

Compliance

UKCA	Yes	CE	Yes
Energy efficiency class	This product contains a light source of energy efficiency class B	SmartScan wireless standards compliance	Europe: EN 300 220-1 V2.4.1/ EN 301 489-3 V1.6.1. Australasia: ACMA 2014 Radio Communication Standard 2014. Thorlux Patented Wireless Technology - GB2575724

Dimensions

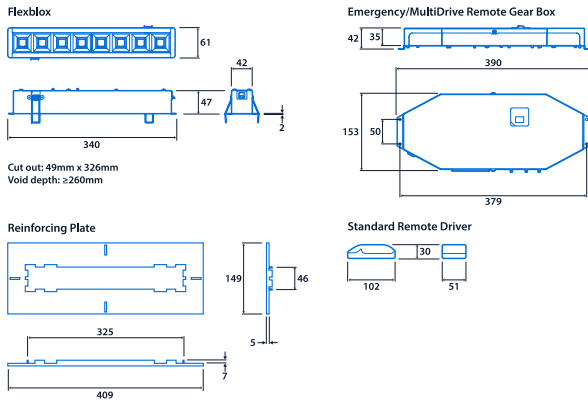

View the range



Information is correct as of 16 Oct 2024, however must not be interpreted as a guarantee of individual product performance and/or characteristics. We reserve the right to alter specifications and designs without prior notice.