

High performance LED pole top luminaires

Stylish IP66 rated pole top amenity luminaire with aluminium cast body and spigot adaptor. UV stabilised polycarbonate cover rated IP66 and IK10. Integral high quality LED driver.

Applications: car parks, amenity areas and hospital estates.

- Integral high efficiency driver
- Extremely efficient and long system life up to 100,000 hours
- Fits 76mm columns as standard (60mm to special order)
- Photocell option
- Zero upward light



IP66

IK10

Up to 136.3 LL/CW

LUXGUARD

Specification

Mounting	Column	IP rating	IP66
Impact rating	IK10	Windage rating	0.04 m ²

Lighting

Optic	Clear cover	Lumen output	5,380 lm - 13,560 lm
Efficacy	Up to 136.3 LL/CW		

Power

LED power	37 W - 101 W	Circuit power	42 W - 110 W
-----------	--------------	---------------	--------------

LED characteristics

CRI	70+	Colour temperature	4000 K
Rated life (hours)	100 K - L80/B10		

Dimensions

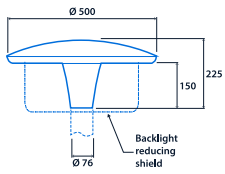

View the
range



Information is correct as of 21 Nov 2024, however must not be interpreted as a guarantee of individual product performance and/or characteristics. We reserve the right to alter specifications and designs without prior notice.