

Adjustable recessed accent downlights

Recessed mounted display luminaires. 355° azimuth adjustment and a 60° vertical adjustment. 14 W or 20 W - 30° or 38° beam versions.

Applications: reception areas, retail, display, halls of residence, hotels, restaurants, public buildings.

- 38° beam angle
- 355° azimuth adjustment
- 60° vertical adjustment
- Supplied with remote gear unit fitted with 2 m lead
- Luminaires can be supplied pre-wired with a purpose made 1 m connection lead for plugging directly into the Smart Hub
- Fitted with CRI 90 LEDs with enhanced R9 value. Suitable for retail applications

Notes: Black and silver finishes and CRI 80 version available to special order (minimum order quantity applies)

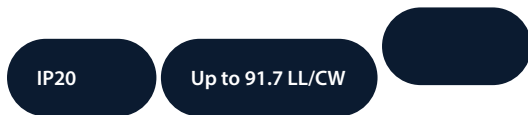

Specification

| | | | |
|----------|----------|-----------|------|
| Mounting | Recessed | IP rating | IP20 |
|----------|----------|-----------|------|

Lighting

| | | | |
|--------------|---------------------|----------|------------------|
| Lumen output | 1,430 lm - 2,110 lm | Efficacy | Up to 91.7 LL/CW |
|--------------|---------------------|----------|------------------|

Power

| | | | |
|-----------|-------------|---------------|-------------|
| LED power | 14 W - 20 W | Circuit power | 17 W - 23 W |
|-----------|-------------|---------------|-------------|

LED characteristics

| | | | |
|--------------------|----------------|--------------------|------------------|
| CRI | 90+ | Colour temperature | 3000 K 4000 K |
| Rated life (hours) | 50 K - L70/B10 | | |

Dimensions

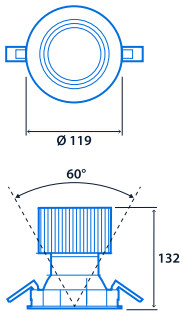

Cut-out - Ø 110
Minimum ceiling void - 180

Standard Remote Driver

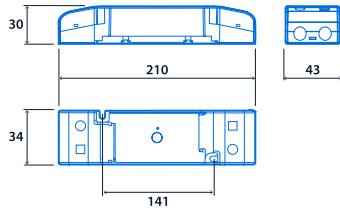

Information is correct as of 21 Nov 2024, however must not be interpreted as a guarantee of individual product performance and/or characteristics. We reserve the right to alter specifications and designs without prior notice.